

MOS FET Relays

G3VM-3(F)L

Analog-switching MOS FET Relay with 350-V Load Voltage and Current Limit.

- Approved standards: UL1577 (File No. E80555)

Application Examples

- Electronic automatic exchange systems
- Multi-functional telephones
- Cordless telephones
- Measuring devices

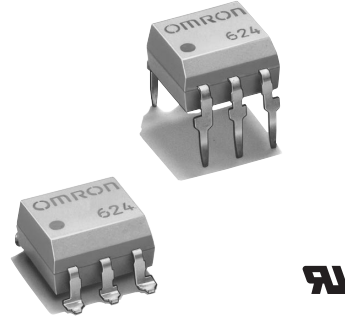

Note: The actual product is marked differently from the image shown here.

List of Models

Contact form	Terminals	Load voltage (peak value)	Model	Current limit	Number per stick	Number per tape
SPST-NO	PCB terminals	350 VAC	G3VM-3L	Yes	50	---
	Surface-mounting terminals		G3VM-3FL			---
			G3VM-3FL(TR)			1,500

Dimensions

Note: All units are in millimeters unless otherwise indicated.

G3VM-3L

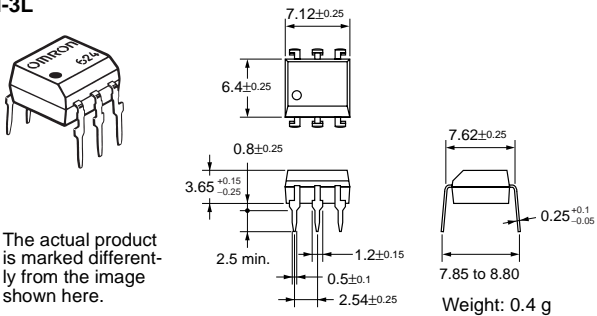

G3VM-3FL

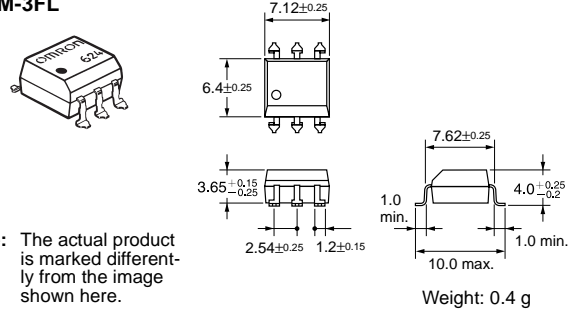

Terminal Arrangement/Internal Connections (Top View)

G3VM-3L

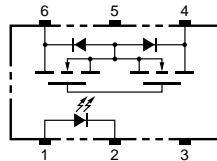

G3VM-3FL

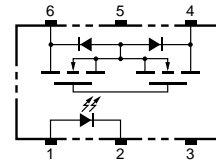

PCB Dimensions (Bottom View)

G3VM-3L

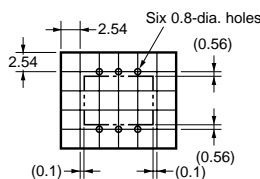

Actual Mounting Pad Dimensions (Recommended Value, Top View)

G3VM-3FL

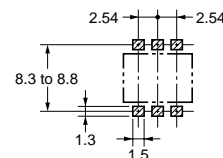

Absolute Maximum Ratings (Ta = 25°C)

Item	Symbol	Rating	Unit	Measurement Conditions	
Input	LED forward current	I_F	50	mA	
	Repetitive peak LED forward current	I_{FP}	1	A	100 μ s pulses, 100 pps
	LED forward current reduction rate	$\Delta I_F/^\circ\text{C}$	-0.5	mA/°C	Ta \geq 25°C
	LED reverse voltage	V_R	5	V	
	Connection temperature	T_j	125	°C	
Output	Output dielectric strength	V_{OFF}	350	V	
	Continuous load current	I_O	120	mA	
	ON current reduction rate	$\Delta I_{ON}/^\circ\text{C}$	-1.2	mA/°C	Ta \geq 25°C
	Connection temperature	T_j	125	°C	
Dielectric strength between input and output (See note 1.)		V_{I-O}	2,500	Vrms	AC for 1 min
Operating temperature		T_a	-40 to +85	°C	With no icing or condensation
Storage temperature		T_{stg}	-55 to +125	°C	With no icing or condensation
Soldering temperature (10 s)		---	260	°C	10 s

Note: 1. The dielectric strength between the input and output was checked by applying voltage between all pins as a group on the LED side and all pins as a group on the light-receiving side.

Electrical Characteristics (Ta = 25°C)

Item	Symbol	Minimum	Typical	Maximum	Unit	Measurement conditions	
Input	LED forward voltage	V_F	1.0	1.15	1.3	V	$I_F = 10$ mA
	Reverse current	I_R	---	---	10	μ A	$V_R = 5$ V
	Capacity between terminals	C_T	---	30	---	pF	$V = 0$, $f = 1$ MHz
	Trigger LED forward current	I_{FT}	---	---	3	mA	$I_O = 120$ mA
Output	Maximum resistance with output ON	R_{ON}	---	22	35	Ω	$I_F = 5$ mA, $I_O = 120$ mA
	Current leakage when the relay is open	I_{LEAK}	---	---	1.0	μ A	$V_{OFF} = 350$ V
Limit current	I_{LIM}	150	---	300	mA	$I_F = 5$ mA, $V_{DD} = 5$ V, $t = 5$ ms	
Capacity between I/O terminals	C_{I-O}	---	0.8	---	pF	$f = 1$ MHz, $V_s = 0$ V	
Insulation resistance	R_{I-O}	1,000	---	---	M Ω	$V_{I-O} = 500$ VDC, $RoH \leq 60\%$	
Turn-ON time	t_{ON}	---	---	1.0	ms	$I_F = 5$ mA, $R_L = 200 \Omega$, $V_{DD} = 20$ V (See note 2.)	
Turn-OFF time	t_{OFF}	---	---	1.0	ms		

Note: 2. Turn-ON and Turn-OFF Times

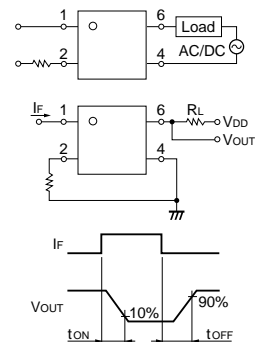

Recommended Operating Conditions

Use the G3VM under the following conditions so that the Relay will operate properly.

Item	Symbol	Minimum	Typical	Maximum	Unit
Output dielectric strength	V_{DD}	---	---	280	V
Operating LED forward current	I_F	5	7.5	25	mA
Continuous load current	I_O	---	---	120	mA
Operating temperature	T_a	-20	---	65	°C

Engineering Data

Load Current vs. Ambient Temperature

G3VM-3(F)L

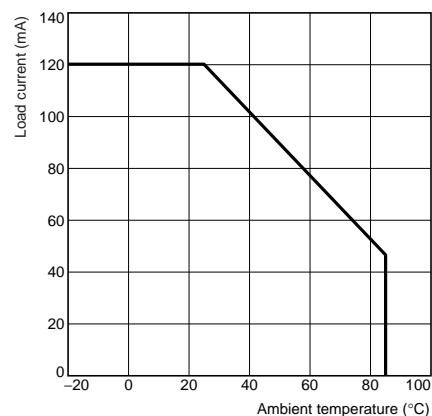

Safety Precautions

Refer to page 6 for precautions common to all G3VM models.